

Passend für/Suitable for Visacrem

Magnetventile/Solenoid valves

Scem/Parker



Abb. Pict.	Bestell-Nr. Order-No.	Beschreibung Description
1	370057	kpl., 3 Wege, 230VAC cpl., 3 ways, 230VAC
2	370060	kpl., 3 Wege, mit Kabel, 230VAC cpl., 3 ways, with cable, 230VAC
3	370062	Ventilkörper Solenoid square pin



Abb. Pict.	Bestell-Nr. Order-No.	Beschreibung Description
1	370212	kpl., 3 Wege, 230VAC cpl., 3 ways, 230VAC
2	370206	kpl., 2 Wege, 230VAC cpl., 2 ways, 230VAC
3	371029	Magnetspule, 230VAC Magnetic coil, 230VAC
4	371033	Magnetspule, mit Kabel, 230VAC Magnetic coil, with cable, 230VAC

Scem/Parker



Abb. Pict.	Bestell-Nr. Order-No.	Beschreibung Description
1	370053	kpl., 3 Wege, 230VAC cpl., 3 ways, 230VAC
2	370061	Ventilkörper, 3 Wege Solenoid square pin, 3 ways
3	371031	Magnetspule, 230VAC Magnetic coil, 230VAC

Magnetventile/Solenoid valves

ODE



Abb. Pict.	Bestell-Nr. Order-No.	Beschreibung Description
1	370203	kpl., 3 Wege, 230VAC cpl., 3 ways, 230VAC
2	370208	kpl., 1/8", 2 Wege cpl., 1/8, 2 ways
3	371150	Magnetspule, 230VAC Magnetic coil, 230VAC

Zubehör/Accessories



Abb. Pict.	Bestell-Nr. Order-No.	Beschreibung Description
1	371090	Stecker/groß Plug/big
2	371095	O-Ring (Viton) O-ring (viton)
3	371100	O-Ring (Silikon) O-ring (silicon)

Pressostate, Thermostate/Pressure switches, thermostats



Abb. Pict.	Bestell-Nr. Order-No.	Beschreibung Description
1	541021	Pressostat, 3-polig Pressure switch, 3 poles
2	390166	Sicherheitsthermostat, 3-polig Safety thermostat, 3 poles

Schalter/Switches



Abb. Pict.	Bestell-Nr. Order-No.	Beschreibung Description
1	346084	Schalter, 2-polig Switch, 2 poles
2	346085	Knopf Button
3	346037	Taster Push button
4	345105	Mikroschalter Micro switch

Schalter/Switches



Abb. Pict.	Bestell-Nr. Order-No.	Beschreibung Description
1	346133	Schalter/gelb (KB) Switch(yellow (KB)
2	346134	Schalter/rot (KB) Switch/red (KB)
3	346135	Signallampe (KB) Signal lamp (KB)



Abb. Pict.	Bestell-Nr. Order-No.	Beschreibung Description
1	346036	Schalter, 2-polig Switch, 2 poles
2	345033	Schalter, 2-polig Switch, 2 poles



Abb. Pict.	Bestell-Nr. Order-No.	Beschreibung Description
1	346128	Taster (GX) Push button (GX)
2	346129	Schalter (GX) Switch (GX)



Abb. Pict.	Bestell-Nr. Order-No.	Beschreibung Description
1	346130	Schalter (KB) Switch (KB)
2	346131	Schalter (KB) Switch (KB)
3	346132	Signallampe (KB) Signal lamp (KB)

Niveauregler/Level controllers

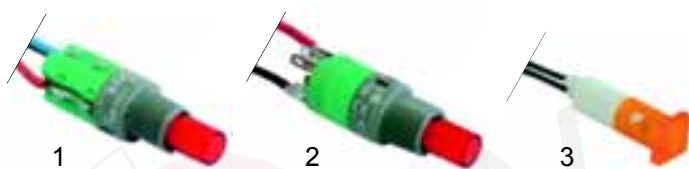

Abb. Pict.	Bestell-Nr. Order-No.	Beschreibung Description
1	400237	Niveauregler, RL30/1E-2C/8, Gicar 9.1.00.10 Level controller, RL30/1E-2C/8, Gicar 9.1.00.10
2	380137	Socket, 8-polig Base, 8 poles
3	400422	Niveauregler Level controller
4	400020	Niveausonde, 150mm Level probe, 150mm

Relais/Relays



Pos. Item	Bestell-Nr. Order-No.	Beschreibung Description
1	380475	Relais, 230V Relay, 230V

Passend für/Suitable for Visacrem

Flow-Meter/Flow meter



Abb. Pict.	Bestell-Nr. Order-No.	Beschreibung Description
1	400004	Flowmeter, 1/4" Flowmeter, 1/4"
2	400256	Stecker Plugs
3	400257	Zählrad Flowmeter reel
4	400258	Gehäusedichtung Case gasket

Tastaturen/Key push buttons



Abb. Pict.	Bestell-Nr. Order-No.	Beschreibung Description
1	400381	Tastatur/Service (KB) Key push button/Service (KB)
2	400380	Tastatur, 1 Gruppe (KB) Key push button, 1 group (KB)
3	400501	Tastatur, 2 - 4 Gruppen (KB) Key push button, 2 - 4 groups (KB)



Abb. Pict.	Bestell-Nr. Order-No.	Beschreibung Description
1	400502	Folientastatur/Service (KB) Push button panel/Service (KB)
2	400384	Folientastatur/rechts (KB) Push button panel/right (KB)
3	400383	Folientastatur (KB) Push button panel (KB)

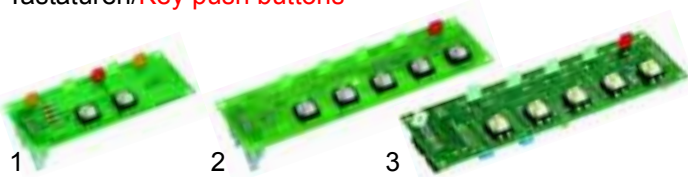

Abb. Pict.	Bestell-Nr. Order-No.	Beschreibung Description
1	400503	Folientastatur/Ein-Aus-rechts Push button panel/On-Out-Right
2	400386	Folientastatur/Gruppe Push button panel/group

Tastaturen/Key push buttons

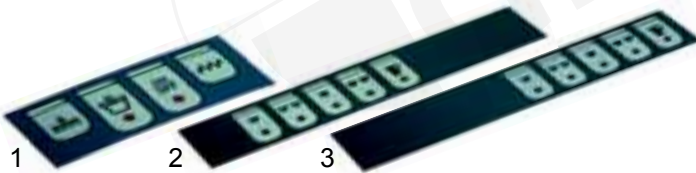

Abb. Pict.	Bestell-Nr. Order-No.	Beschreibung Description
1	400504	Folientastatur (GX) Push button panel (GX)

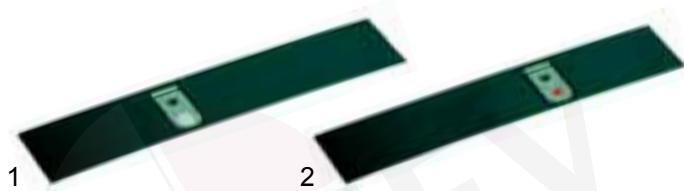
Elektronik/Electronics



Abb. Pict.	Bestell-Nr. Order-No.	Beschreibung Description
1	400327	Elektronik-Box/kpl., 2 Gruppen Elektronik box/cpl., 2 groups
1	400483	Elektronik-Box/kpl., 3 Gruppen Elektronik box/cpl., 3 groups
2	400328	Basisplatine, 2 Gruppen Base board, 2 groups
2	400484	Basisplatine, 3 Gruppen Base board, 3 groups



Abb. Pict.	Bestell-Nr. Order-No.	Beschreibung Description
1	400331	Gruppenplatine Group board
2	400330	Dosierplatine Dosing board
3	400329	Niveaureglerplatine Level controller board
4	400332	Verbindungskabel/Tastatur, 2 Gruppen Connection cable/key push button, 2 groups
4	400485	Verbindungskabel/Tastatur, 3 Gruppen Connection cable/key push button, 3 groups

Heizkörper/Heaters

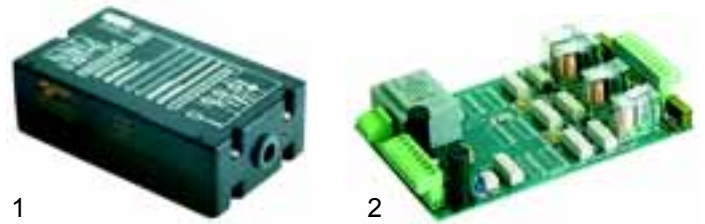
Mit Tauchhülse
With immersion socket

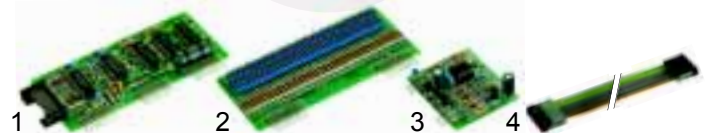

Abb. Pict.	Bestell-Nr. Order-No.	Beschreibung Description
1	417116	Heizkörper, 1 Gruppe, 1800W, 230V Heater, 1 group, 1800W, 230V
2	417001	Heizkörper, 2 Gruppen, 2600W, 230V Heater, 2 group, 2600W, 230V
3	417109	Heizkörper, 3 Gruppen, 3700W, 230V Heater, 3 groups, 3700W, 230V



Abb. Pict.	Bestell-Nr. Order-No.	Beschreibung Description
1	417120	Heizkörper, 1 Gruppe, 2500W, 230V Heater, 1 group, 2500W, 230V
2	417121	Heizkörper, 2 Gruppen, 1000W, 230V Heater, 2 groups, 1000W, 230V
2	417122	Heizkörper, 2 Gruppen, 1500W, 230V Heater, 2 groups, 1500W, 230V
3	417123	Heizkörper, 3 Gruppen, 1250W, 230V Heater, 3 groups, 1250W, 230V
3	417124	Heizkörper, 3 Gruppen, 2500W, 230V Heater, 3 groups, 2500W, 230V

Heizkörper/Heaters



Abb. Pict.	Bestell-Nr. Order-No.	Beschreibung Description
1	417151	Heizkörper, 2 Gruppen, 1300W, 230V Heater, 2 group, 1300W, 230V
2	417152	Heizkörper, 3 Gruppen, 1900W, 230V Heater, 3 groups, 1900W, 230V
2	417153	Heizkörper, 3 Gruppen, 1900W/400V Heater, 3 groups, 1900W/400V
3	528008	Heizkörperdichtung (Klingerit) Heater gasket (klingerit)
3	528740	Heizkörperdichtung (Teflon) Heater gasket (teflon)

Kesseldichtungen/Pot gaskets



Abb. Pict.	Bestell-Nr. Order-No.	Beschreibung Description
1	528166	Dichtung (Klingerit) Gasket (klingerit)
2	528741	Dichtung (Teflon) Gasket (teflon)

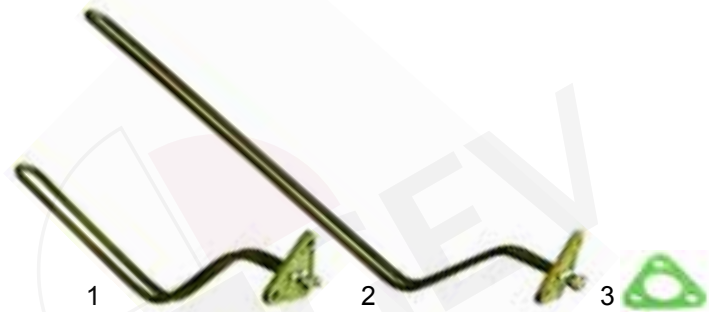

Abb. Pict.	Bestell-Nr. Order-No.	Beschreibung Description	Gerätetyp Device type
1	528930	Dichtung Gasket	KB
2	528931	Dichtung (Modern) Gasket (Modern)	KB

Manometer/Manometers



Abb. Pict.	Bestell-Nr. Order-No.	Beschreibung Description
1	541244	Manometer, 0 - 3bar Manometer, 0 - 3bar
2	541246	Manometer, 0 - 12bar Manometer, 0 - 12bar
3	541245	Manometer, 0 - 24bar Manometer, 0 - 24bar

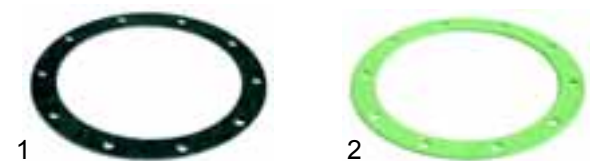

Abb. Pict.	Bestell-Nr. Order-No.	Beschreibung Description
1	541236	Manometer (GX), 0 - 3bar Manometer (GX), 0 - 3bar
2	541238	Manometer (GX), 0 - 18bar Manometer (GX), 0 - 18bar



Abb. Pict.	Bestell-Nr. Order-No.	Beschreibung Description
1	541237	Manometer (GX), 0 - 3bar Manometer (GX), 0 - 3bar
2	541239	Manometer (GX), 0 - 18bar Manometer (GX), 0 - 18bar



Abb. Pict.	Bestell-Nr. Order-No.	Beschreibung Description
1	541241	Manometer (KB), 0 - 3bar Manometer (KB), 0 - 3bar
2	541240	Manometer (KB), 0 - 16bar Manometer (KB), 0 - 16bar

Ventile/Valves



Abb. Pict.	Bestell-Nr. Order-No.	Beschreibung Description
1	529312	Sicherheitsventil, 1,8bar, 3/8" Safety valve, 1,8bar, 3/8"
2	529316	Sicherheitsventil/plombiert, 1,8bar, 3/8" Safety valve/sealed, 1,8bar, 3/8"
3	529303	Entlüftungsventil (CNS), 1/4" Empty valve (stainless steel), 1/4"
4	529361	Cu-Dichtung, 1/4" Cu-gasket, 1/4"
5	529349	Cu-Dichtung, 3/8" Cu-gasket, 3/8"



Abb. Pict.	Bestell-Nr. Order-No.	Beschreibung Description
1	529317	Expansionsventil Expansion valve
2	529301	Rückschlagventil (außen), 3/8" Non-return valve (outer), 3/8"
3	529346	Rückschlagventil (innen), 3/8" Non-return valve (inner), 3/8"

Wasserstandsglas/Water level glass



Abb. Pict.	Bestell-Nr. Order-No.	Beschreibung Description
1	529429	Wasserstandsglas Water level
2	528745	O-Ring O-ring
3	528682	Pressscheibe Pressure washer
4	529434	Kunststoffabdeckung Plastic cap

Passend für/Suitable for Visacrem

Wasserfüllventil/Water intake valve

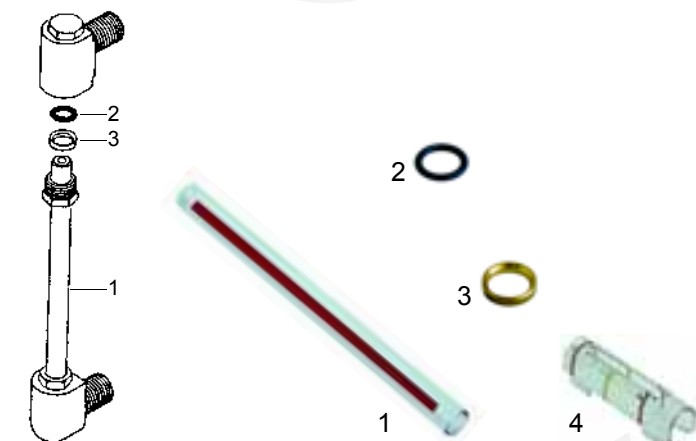

Abb. Pict.	Bestell-Nr. Order-No.	Beschreibung Description
1	529854	Wasserfüllventil/kpl., 1/4" (GX) Water intake valve/cpl., 1/4" (GX)
2	528742	Dichtung Gasket
3	528750	Dichtung Gasket
4	528749	Feder Spring



Pos. Item	Bestell-Nr. Order-No.	Beschreibung Description
1	528746	Wasserfüllventil (C70/80) Water intake valve (C70/80)

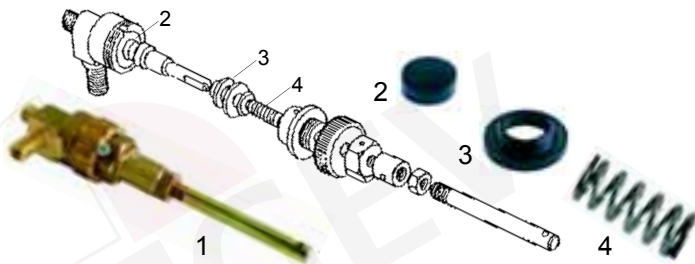

Abb. Pict.	Bestell-Nr. Order-No.	Beschreibung Description
1	528742	Dichtung Gasket
2	528400	O-Ring O-ring
3	528743	Feder Spring
4	528935	Lager Support

Hähne/Taps



Abb. Pict.	Bestell-Nr. Order-No.	Beschreibung Description
1	528748	Hahn (Dampf/Wasser) /kpl. (GX) Tap (Steam/water) /cpl. (GX)
2	529856	Hahn (Dampf/Wasser) /kpl. (KB) Tap (Steam/water) /cpl. (KB)
3	528932	Griff (KB) Handle (KB)
4	528933	Feder (KB) Spring (KB)

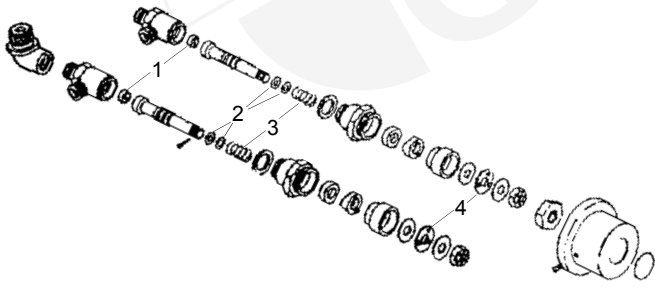

Abb. Pict.	Bestell-Nr. Order-No.	Beschreibung Description
1	528742	Dichtung Gasket
2	528749	Feder Spring
3	528750	Dichtung Gasket

Rohre/Pipes



Abb. Pict.	Bestell-Nr. Order-No.	Beschreibung Description
1	529857	Dampfrohr/links Steampipe/left
1	529858	Dampfrohr/rechts Steampipe/right
2	529859	Wasserrohr Waterpipe
3	528401	Dichtung Gasket
4	528184	Feder Spring
5	528653	Scheibe Washer
6	528654	Buchse (Nylon) Bush (nylon)
7	528655	O-Ring O-rig

Gruppe/Group



Abb. Pict.	Bestell-Nr. Order-No.	Beschreibung Description
1	528763	Gruppendichtung Group gasket



Abb. Pict.	Bestell-Nr. Order-No.	Beschreibung Description
2	528659	Endkappe Ending cap
3	528520	Dichtung Gasket
4	528668	Feder Spring
5	528669	Filter Filter
6	528670	Düse Nozzle
7	528765	O-Ring (Viton) O-ring (viton)
8	528766	Verlängerung, M6 Lengthening, M6
8	528767	Verlängerung, M8 Lengthening, M8
9	528662	Cu-Dichtung Cu-Gasket

Dusche/Shower

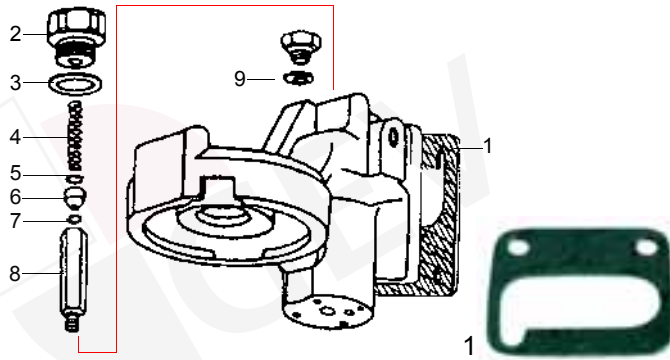

Abb. Pict.	Bestell-Nr. Order-No.	Beschreibung Description
1	529081	Verteiler (KB) Divider (KB)
2	529080	Dusche (KB) Shower (KB)
3	529092	Dusche (GX + KB alt) Shower (GX + KB old)

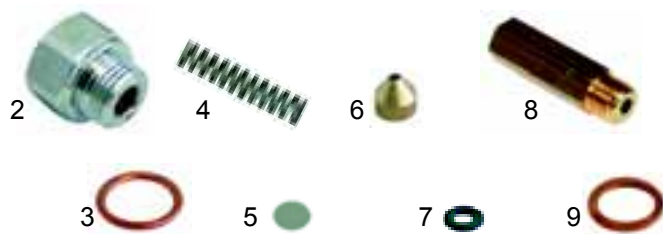
Siebträgerdichtungen/Filter holder gaskets



Abb. Pict.	Bestell-Nr. Order-No.	Beschreibung Description
1	528033	Distanzeinlage, 71 x 68mm Shirn gasket, 71 x 68mm
2	528030	Siebträgerdichtung, 73 x 57 x 8mm Filter holder gasket, 73 x 57 x 8mm
2	528031	Siebträgerdichtung, 73 x 57 x 8,5mm Filter holder gasket, 73 x 57 x 8,5mm
2	528032	Siebträgerdichtung, 73 x 57 x 9mm Filter holder gasket, 73 x 57 x 9mm
3	529079	Siebträgerfeder Filter holder spring

Filter/Filters



Abb. Pict.	Bestell-Nr. Order-No.	Beschreibung Description
1	529021	Filter, 1 Tasse (7g) Filter, 1 cup (7g)
2	529022	Filter, 2 Tassen (14g) Filter, 2 cups (14g)
3	529023	Blindfilter Blindfilter

Filterträger/Filter holder



Abb. Pict.	Bestell-Nr. Order-No.	Beschreibung Description
1	529054	Siebträger Filter holder
2	529111	Siebträgergriff Filter holder handle
3	529112	Siebträgergriff Filter holder handle
4	528693	Schraube, M8 x 20 Srew, M8 x 20

Siebträger/Filter holder



Abb. Pict.	Bestell-Nr. Order-No.	Beschreibung Description
1	529055	Siebträger, M10 Filter holder, M10
2	529053	Siebträgergriff, M10 Filter holder handle, M10

Siebträger/Filter holder



Abb. Pict.	Bestell-Nr. Order-No.	Beschreibung Description
1	529041	Siebträger, M12 Filter holder, M12
2	529045	Siebträgergriff, M12 Filter holder handle, M12

Filter/Filters



Abb. Pict.	Bestell-Nr. Order-No.	Beschreibung Description
1	529012	Filter, 1 Tasse (6g) Filter, 1 cup (6g)
1	529011	Filter, 1 Tasse (7g) Filter, 1 cup (7g)
2	529014	Filter, 2 Tassen (12g) Filter, 2 cups (12g)
2	529013	Filter, 2 Tassen (14g) Filter, 2 cups (14g)
3	529023	Blindfilter Blindfilter

Ausläufe/Spouts



Abb. Pict.	Bestell-Nr. Order-No.	Beschreibung Description
1	529001	Auslauf 3/8", 1 Weg lang Spout 3/8", one way long
2	529003	Auslauf 3/8", 1 Weg gebogen Spout 3/8", one way curved
3	529007	Auslauf 3/8", 2 Wege kurz Spout 3/8", two way short

Siebträger/Filter holder

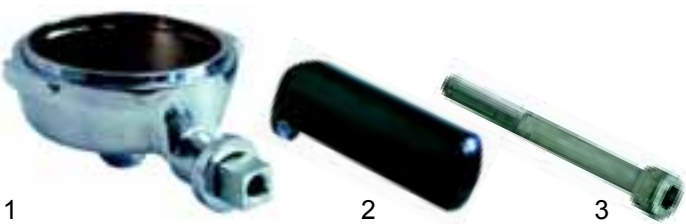

Abb. Pict.	Bestell-Nr. Order-No.	Beschreibung Description
1	529150	Filterträger Filter holder
2	529112	Griff Handle
3	529123	Schraube Screw